

# CONNECTORS SERIES

接 頭 系 列

CE RoHS



## 防水盒接頭

## LIQUID-TIGHT CONNECTORS

## TYPE-FABB (Straight)

型號 Catalog No.	規格 Nominal Size	I.D.	尺寸 Dimension (mm)				牙規格 Thread	包裝 數量 pcs/bag	重量 Weight (g/pc)
			A	B	C	E			
AFABB00300000	3/8"	11.3	27.5	33.5	12.5	20.9	PF1/2"	50	42
AFABB00400000	1/2"	14.8	32.8	33.5	12.5	20.9	PF1/2"	50	53
AFABB00600000	3/4"	19.4	39.2	40.0	15.5	26.4	PF3/4"	50	84
AFABB001000000	1"	25.0	46.6	43.5	16.5	33.2	PF1"	50	124
AFABB001200000	1 1/4"	33.5	56.0	44.5	17.0	41.9	PF1 1/4"	10	174
AFABB001400000	1 1/2"	38.5	63.0	53.0	20.5	47.8	PF1 1/2"	10	244
AFABB002000000	2"	49.5	77.0	58.0	21.5	59.6	PF2"	10	358
AFABB002400000	2 1/2"	60.0	103.5	95.5	26.5	75.2	PF2 1/2"	-	1360
AFABB003000000	3"	75.0	121.0	101.0	23.0	87.9	PF3"	-	1940
AFABB004000000	4"	98.0	159.0	115.0	30.5	113.0	PF4"	-	3250

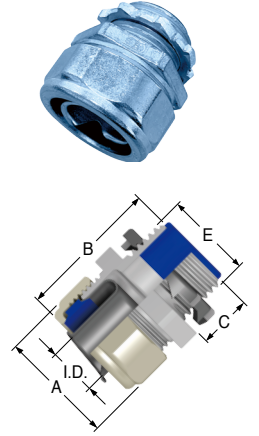

## TYPE-FABL (90° Angle)

型號 Catalog No.	規格 Nominal Size	I.D.	尺寸 Dimension (mm)				牙規格 Thread	包裝 數量 pcs/bag	重量 Weight (g/pc)
			A	B	C	E			
AFABL003000000	3/8"	11.3	27.5	47.5	12.5	20.9	PF1/2"	50	62
AFABL004000000	1/2"	14.8	32.8	51.0	12.5	20.9	PF1/2"	50	79
AFABL006000000	3/4"	19.4	39.2	61.0	15.5	26.4	PF3/4"	50	129
AFABL001000000	1"	25.0	46.6	70.0	16.5	33.2	PF1"	25	194
AFABL001200000	1 1/4"	33.5	56.0	81.0	17.0	41.9	PF1 1/4"	10	272
AFABL001400000	1 1/2"	38.5	63.0	91.0	20.5	47.8	PF1 1/2"	10	379
AFABL002000000	2"	49.5	77.0	111.5	21.5	59.6	PF2"	10	554
AFABL002400000	2 1/2"	60.0	103.5	212.8	25.5	75.2	PF2 1/2"	-	2810
AFABL003000000	3"	75.0	121.0	244.4	26.0	87.9	PF3"	-	3520
AFABL004000000	4"	98.0	159.0	319.0	34.0	113.0	PF4"	-	6830

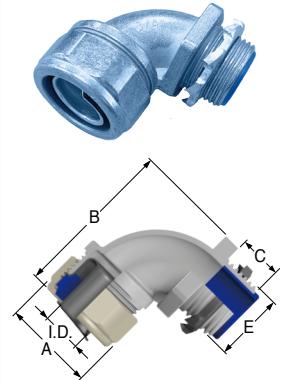

## TYPE-FABK (45° Angle)

型號 Catalog No.	規格 Nominal Size	I.D.	尺寸 Dimension (mm)				牙規格 Thread	包裝 數量 pcs/bag	重量 Weight (g/pc)
			A	B	C	E			
AFABK003000000	3/8"	11.3	27.5	47.0	12.5	20.9	PF1/2"	50	56
AFABK004000000	1/2"	14.8	31.8	47.0	12.5	20.9	PF1/2"	50	68
AFABK006000000	3/4"	19.4	38.0	56.5	13.5	26.4	PF3/4"	50	107
AFABK001000000	1"	25.0	45.0	66.5	15.0	33.2	PF1"	25	156
AFABK001200000	1 1/4"	33.0	56.5	73.0	16.0	41.9	PF1 1/4"	10	235
AFABK001400000	1 1/2"	38.5	63.0	84.0	16.5	47.8	PF1 1/2"	10	311
AFABK002000000	2"	48.5	77.0	100.0	18.0	59.6	PF2"	10	506
AFABK002400000	2 1/2"	61.0	95.0	108.0	23.0	75.2	PF2 1/2"	-	982
AFABK003000000	3"	75.0	107.5	127.0	24.5	87.9	PF3"	-	1336
AFABK004000000	4"	98.0	159.0	223.5	30.5	113.0	PF4"	-	5610

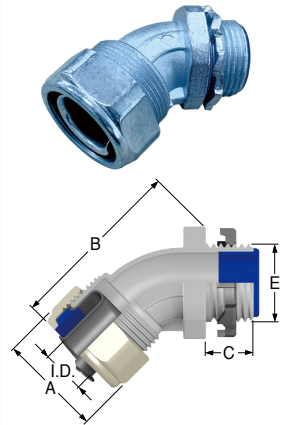

- 材 質：鋅合金。
- 牙規格：PF牙。
- 表面電鍍：鍍 (FABX)、鍍鎳 (FNBX)。
- 製作範例：遵照美國UL規範。
- 防護等級IP66。
- 上列金屬接頭配合金屬軟管使用。

- Material : Zinc alloy.
- Thread specification : PF.
- Surface-plated : Zine ( FABX ), Nnickle ( FNBX ).
- Production example : According to US UL standard.
- Protection degree : IP66.
- The connectors suitable for flexible conduits.

# 防水管接頭

## COMBINATION CONNECTORS

### TYPE-SAPB

型號 Catalog No.	規格 Nominal Size	尺寸 Dimension (mm)					牙規格 Thread	包裝 數量 pcs/bag	重量 Weight (g/pc)
		I.D.	A	B	C	E			
ASAPB00300000	3/8"	11.3	27.5	33.5	18.5	19.4	PF1/2"	50	45
ASAPB00400000	1/2"	14.8	32.8	34.5	19.5	19.4	PF1/2"	50	55
ASAPB00600000	3/4"	19.4	39.2	42.0	20.0	24.5	PF3/4"	50	88
ASAPB00100000	1"	25.0	46.6	45.0	21.5	30.8	PF1"	50	122
ASAPB00120000	1 1/4"	33.5	56.0	48.5	24.5	39.2	PF1 1/4"	10	162
ASAPB00140000	1 1/2"	38.5	63.0	53.0	26.5	45.4	PF1 1/2"	10	232
ASAPB00200000	2"	49.5	77.0	61.3	28.5	56.8	PF2"	10	341
ASAPB00240000	2 1/2"	60.0	103.5	88.0	33.0	73.3	PF2 1/2"	-	1190
ASAPB00300000	3"	75.0	121.0	103.0	39.0	86.2	PF3"	-	1720
ASAPB00400000	4"	98.0	159.0	112.5	45.0	111.5	PF4"	-	2900

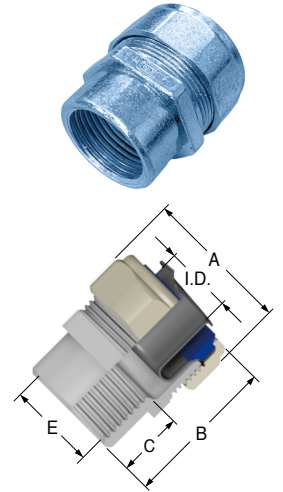

### TYPE-SAPE

型號 Catalog No.	規格 Nominal Size	尺寸 Dimension (mm)					包裝 數量 pcs/bag	重量 Weight (g/pc)
		I.D.	A	B	C	E		
ASAPE00300000	3/8"	11.3	27.5	42.0	18.0	16.0	50	52
ASAPE00400000	1/2"	14.8	32.8	34.5	18.5	19.5	50	59
ASAPE00600000	3/4"	19.4	39.2	41.5	19.5	25.8	50	89
ASAPE00100000	1"	25.0	46.6	45.5	21.0	32.0	50	123
ASAPE00120000	1 1/4"	33.5	56.0	43.5	15.0	38.7	10	160
ASAPE00140000	1 1/2"	38.5	63.0	56.0	21.5	51.5	10	233
ASAPE00200000	2"	49.5	77.0	57.5	21.0	64.5	10	341
ASAPE00240000	2 1/2"	60.0	103.5	92.5	34.0	77.0	-	1170
ASAPE00300000	3"	75.0	121.0	104.0	39.0	90.0	-	1640
ASAPE00400000	4"	98.0	139.0	73.5	23.5	116.2	-	1196

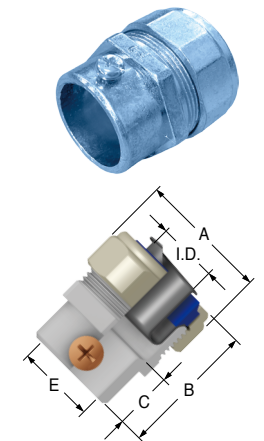

### TYPE-FAFC

型號 Catalog No.	規格 Nominal size	尺寸 Dimension (mm)		包裝 數量 pcs/bag	重量 Weight (g/pc)
		I.D.	B		
AFAFC00300000	3/8"	11.3	19.5	50	5
AFAFC00400000	1/2"	14.8	23.0	50	6
AFAFC00600000	3/4"	19.4	28.6	50	8
AFAFC00100000	1"	25.0	35.5	50	12
AFAFC00120000	1 1/4"	33.5	44.3	10	17
AFAFC00140000	1 1/2"	38.5	50.3	10	24
AFAFC00200000	2"	49.5	63.0	10	39
AFAFC00240000	2 1/2"	60.0	74.0	-	64
AFAFC00300000	3"	75.0	91.5	-	115
AFAFC00400000	4"	98.0	124.5	-	141

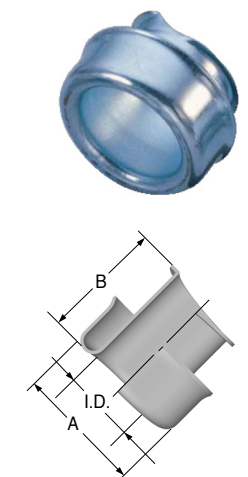

## 塑鋼防水盒接頭

## POLYESTER LIQUID-TIGHT CONNECTORS

## TYPE-PCB (Straight)

型號 Catalog No.	規格 Nominal Size	尺寸 Dimension (mm)					牙規格 Thread	包裝 數量 pcs/bag	重量 Weight (g/pc)
		I.D.	A	B	C	E			
A0PCB00300000	3/8"	11.0	32.5	38.0	13.0	20.9	PF1/2"	50	15.2
A0PCB00400000	1/2"	14.0	36.0	39.3	12.5	20.9	PF1/2"	50	18.0
A0PCB00600000	3/4"	18.2	41.0	41.5	15.0	26.4	PF3/4"	50	23.2
A0PCB001000000	1"	23.1	51.0	47.2	16.0	33.2	PF1"	50	42.4
A0PCB001200000	1 1/4"	32.0	61.5	57.0	18.0	41.9	PF1 1/4"	10	67.4
A0PCB001400000	1 1/2"	38.5	66.5	60.0	18.0	47.8	PF1 1/2"	10	100.8

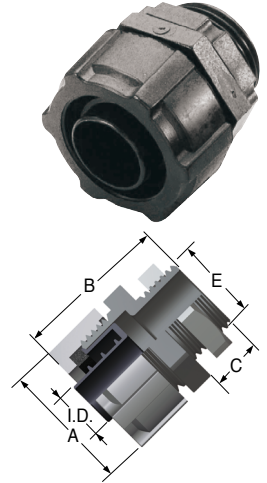

## TYPE-PCL (90° Angle)

型號 Catalog No.	規格 Nominal Size	尺寸 Dimension (mm)					牙規格 Thread	包裝 數量 pcs/bag	重量 Weight (g/pc)
		I.D.	A	B	C	E			
A0PCL00300000	3/8"	11.0	32.5	64.2	12.0	20.9	PF1/2"	50	21.0
A0PCL00400000	1/2"	14.0	36.0	67.0	12.0	20.9	PF1/2"	50	24.2
A0PCL00600000	3/4"	18.2	41.0	76.0	15.0	26.4	PF3/4"	50	35.0
A0PCL001000000	1"	23.1	51.0	97.5	16.0	33.2	PF1"	20	63.6
A0PCL001200000	1 1/4"	32.0	61.5	115.0	18.0	41.9	PF1 1/4"	10	96.0

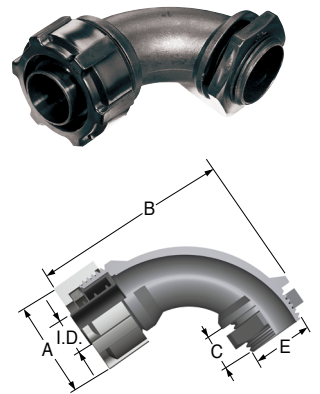

## TYPE-PCF

型號 Catalog No.	規格 Nominal Size	尺寸 Dimension (mm)			包裝 數量 pcs/bag	重量 Weight (g/pc)
		I.D.	A	B		
A0PCF00300000	3/8"	11.0	20.6	18.5	50	1.8
A0PCF00400000	1/2"	14.0	24.2	21.0	50	2.4
A0PCF00600000	3/4"	18.2	29.0	24.0	50	3.6
A0PCF001000000	1"	23.1	36.9	30.7	50	7.1
A0PCF001200000	1 1/4"	32.0	46.5	32.0	10	12.8

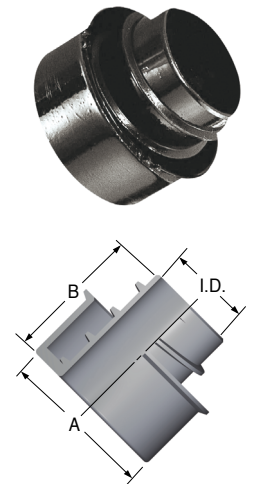

- 上列塑鋼接頭配合金屬軟管使用。
- 防護等級IP66

- The polyester connectors suitable for flexible conduits.
- Protection degree : IP66

# PG牙、M牙金屬接頭

## THREAD PG & M CONNECTORS ADAPTER ( Metal )

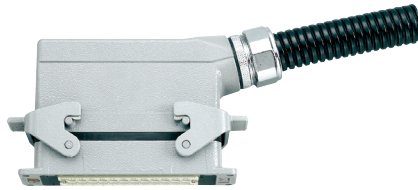

### TYPE-MTB (Straight)

型號 Catalog No.	配管規格 Conduit Size	I.D.	尺寸 Dimension ( mm )				牙規格 Thread	重量 Weight ( g/pc )
			A	B	C	E		
A0MTB000300G07	3/8"	8.0	27.5	32.5	8.0	12.5	PG7	43.8
A0MTB000300G09	3/8"	10.7	27.5	32.5	8.0	15.2	PG9	45.0
A0MTB000300G11	3/8"	11.3	27.5	32.5	8.0	18.6	PG11	45.0
A0MTB000300G13	3/8"	11.3	27.5	32.5	8.0	20.4	PG13.5	47.0
A0MTB000300G16	3/8"	11.3	27.5	32.5	8.0	22.5	PG16	50.0
A0MTB000400G13	1/2"	14.8	32.8	34.4	8.0	20.4	PG13.5	61.0
A0MTB000400G16	1/2"	14.8	32.8	33.2	8.0	22.5	PG16	66.0
A0MTB000600G16	3/4"	19.4	42.0	38.0	8.0	22.5	PG16	100.0
A0MTB000600G21	3/4"	19.4	42.0	40.0	10.0	28.3	PG21	88.0
A0MTB001000G29	1"	25.0	46.6	40.5	10.0	37.0	PG29	130.0
A0MTB001200G36	1 1/4"	33.5	56.0	41.5	12.0	47.0	PG36	162.0
A0MTB000300M16	3/8"	11.3	27.5	32.5	8.0	16.0	M16X1.5	43.0
A0MTB000300M18	3/8"	11.3	27.5	32.5	8.0	18.0	M18X1.5	51.0
A0MTB000300M20	3/8"	11.3	27.5	32.5	8.0	20.0	M20X1.5	43.0
A0MTB000300M25	3/8"	11.3	27.5	32.5	8.0	25.0	M25X1.5	51.0
A0MTB000400M20	1/2"	14.8	32.8	33.2	8.0	20.0	M20X1.5	63.0
A0MTB000400M25	1/2"	14.8	32.8	34.0	8.0	25.0	M25X1.5	80.0
A0MTB000600M25	3/4"	19.4	42.0	38.0	8.0	25.0	M25X1.5	97.0
A0MTB000600M27	3/4"	19.4	42.0	38.0	8.0	27.5	M27.5X1.5	110.0
A0MTB001000M32	1"	25.0	46.6	41.0	10.0	32.0	M32X1.5	106.8
A0MTB001200M40	1 1/4"	33.5	56.0	44.5	14.0	40.0	M40X1.5	174.8

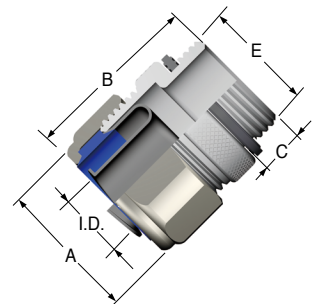

### TYPE-MTL (90° Angle)

型號 Catalog No.	配管規格 Conduit Size	I.D.	尺寸 Dimension ( mm )				牙規格 Thread	重量 Weight ( g/pc )
			A	B	C	E		
A0MTL000300G13	3/8"	11.3	27.5	54.0	9.0	20.4	PG13.5	100.0
A0MTL000400G13	1/2"	14.8	32.8	55.0	9.0	20.4	PG13.5	133.0
A0MTL000400G16	1/2"	14.8	32.8	55.0	9.0	22.5	PG16	133.0
A0MTL000300M20	3/8"	11.3	27.5	48.0	9.0	20.0	M20X1.5	58.8
A0MTL000400M20	1/2"	14.8	32.8	51.0	9.0	20.0	M20X1.5	78.2

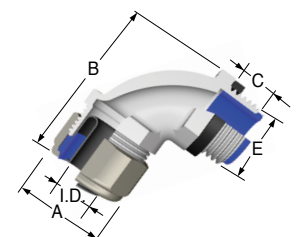

• 上列接頭配合金屬軟管使用。

• The connectors suitable for flexible conduits.

## 軍規轉接頭 (金屬)

## MS-PLUG/CONNECTORS ADAPTER ( Metal )



## TYPE-MAS

型號 Catalog No.	配管規格 Conduit Size	MS 電源 插座規格		牙規格 Thread
		Same MS-3057	MS-Plus Size	
AOMAS00030004A	3/8"	4A	10SL、12S、12	5/8" X24UNEF
AOMAS00030006A	3/8"	6A	14S、14	3/4" X20UNEF
AOMAS00030008A	3/8"	8A	16S、16	7/8" X20UNEF
AOMAS00030010A	3/8"	10A	18	1" X20UNEF
AOMAS00030012A	3/8"	12A	20、22	1 3/16" X18UNEF
AOMAS00040008A	1/2"	8A	16S、16	7/8" X20UNEF
AOMAS00040010A	1/2"	10A	18	1" X20UNEF
AOMAS00040012A	1/2"	12A	20、22	1 3/16" X18UNEF
AOMAS00040016A	1/2"	16A	24、28	1 7/16" X18UNEF
AOMAS00060012A	3/4"	12A	20、22	1 3/16" X18UNEF
AOMAS00060016A	3/4"	16A	24、28	1 7/16" X18UNEF
AOMAS00100016A	1"	16A	24、28	1 7/16" X18UNEF
AOMAS00100020A	1"	20A	32	1 3/4" X18UNS
AOMAS00100024A	1"	24A	36	2" X18UNS
AOMAS00120020A	1 1/4"	20A	32	1 3/4" X18UNS
AOMAS00140024A	1 1/2"	24A	36	2" X18UNS

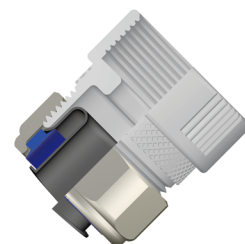

## TYPE-MBS

型號 Catalog No.	配管規格 Conduit Size	MS 電源 插座規格		牙規格 Thread
		長度 Length	MS-Plus Size	
AOMBS000300M13	3/8"	L=13.0	(JAE)	M13 X 1.0
AOMBS000300M18	3/8"	L=14.0	(DDK)	M18 X 1.0
AOMBS000400M24	1/2"	L=6.0		M24 X 1.25
AOMBS000448M26	1/2"	L=48.0		M26.5 X 1.0

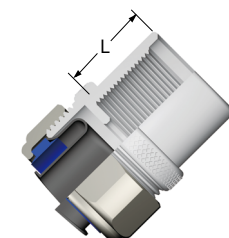

- 上列軍規轉接頭配合金屬軟管使用。
- The connector adapter suitable for flexible conduits.

# 夾牢式防水接頭 (油壓式夾牢不鬆脫)

SQUEEZE LIQUID-TIGHT CONNECTORS (Hydraulic clamp is not loose)

中華民國專利號碼：第M502744號  
R.O.C. Patent No. : M502744

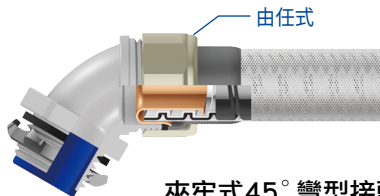
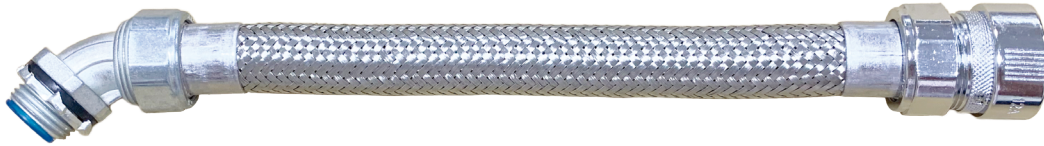

夾牢式45°彎型接頭  
(接頭規範同FABK - 目錄54頁)

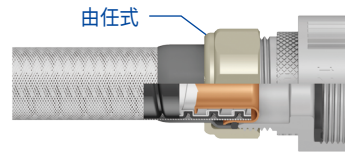

夾牢式軍規轉接頭  
(接頭規範同MAS - 目錄58頁)

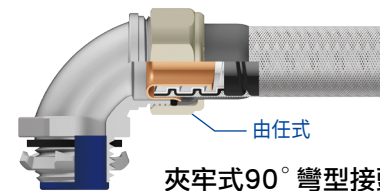

夾牢式90°彎型接頭  
(接頭規範同FABL - 目錄54頁)

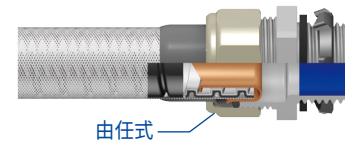

夾牢式直型接頭  
(接頭規範同FABB - 目錄54頁)

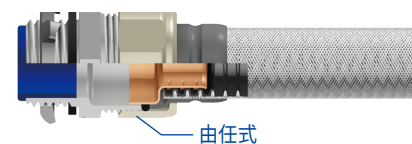
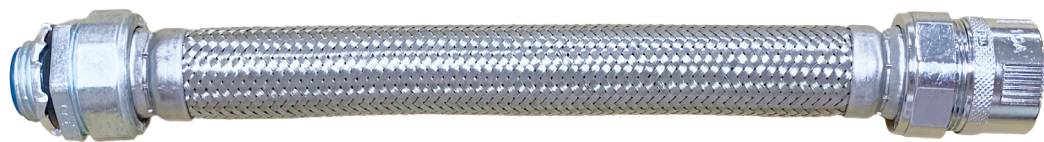

夾牢式直型接頭  
(接頭規範同FABB - 目錄54頁)

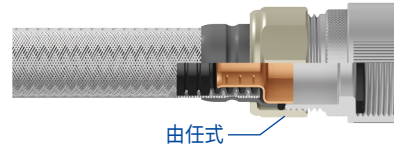

夾牢式軍規轉接頭  
(接頭規範同MAS - 目錄58頁)

- 牙規格：PF牙、PG牙、M牙及軍規轉接頭。
- 上列夾牢式接頭配合金屬編織軟管及尼龍編織軟管使用。
- Thread specification : PF, PG, M, and MS-Plus connectors adapter.
- The squeeze connectors suitable for flexible conduits and corrugated nylon tubes.

防護等級：(Protection degree:)

NK707 系列：I.P.60	NK707 series: I.P.60
NK706 系列：I.P.66以上	NK706 series: I.P.66 and above
NK506 系列：I.P.66以上	NK506 series: I.P.66 and above
NK206 系列：I.P.68	NK206 series: I.P.68

## 金屬電纜接頭

### METAL CABLE GLAND

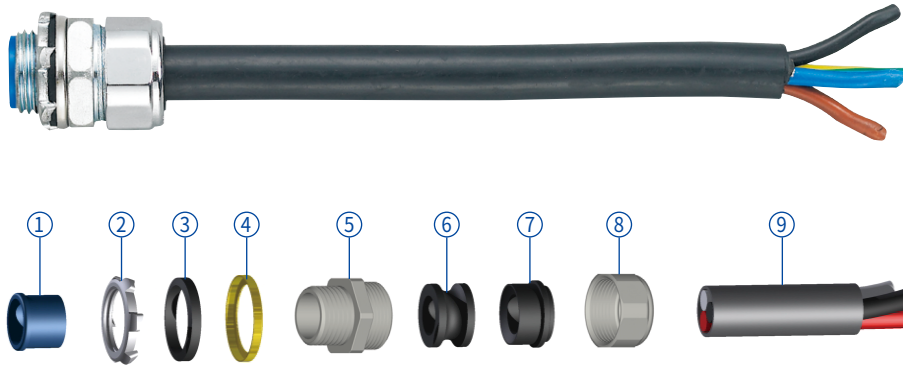

- 1.絕緣套 (Insulating liner)
- 2.太陽型螺帽 (Lock nut)
- 3.油環 (O-Ring)
- 4.金屬油環墊片 (Lock nut)
- 5.接頭本體 (Body)
- 6.束線圈 (Grip seal)
- 7.柱形墊 (Busing)
- 8.後蓋螺帽 (Cap nut)
- 9.電纜線 (Cable)

#### TYPE-KCB(Straight)

型號 Catalog No.	適用電纜線徑 Suit for cable size (mm)	尺寸 Dimension(mm) C E		牙規格 Thread	包裝數量 pcs/bag	金屬螺帽 Metal nut
A0KCB000095F04	6.5 ~ 9.5	13.0	20.9	PF1/2"	50	有 HAVE
A0KCB000130F04	9.0 ~ 13.0	13.0	20.9	PF1/2"	50	有 HAVE
A0KCB000140F04	11.5 ~ 14.0	13.0	20.9	PF1/2"	50	有 HAVE
A0KCB000190F06	15.5 ~ 19.0	16.0	26.4	PF3/4"	50	有 HAVE
A0KCB000095G09	6.5 ~ 9.5	8.0	15.2	PG9	50	有 HAVE
A0KCB000095G11	6.5 ~ 9.5	8.0	18.6	PG11	50	無 NO
A0KCB000095G13	6.5 ~ 9.5	8.0	20.4	PG13.5	50	無 NO
A0KCB000095G16	6.5 ~ 9.5	8.0	22.5	PG16	50	有 HAVE
A0KCB000130G09	9.0 ~ 13.0	8.0	15.2	PG9	50	有 HAVE
A0KCB000130G11	9.0 ~ 13.0	8.0	18.6	PG11	50	無 NO
A0KCB000130G13	9.0 ~ 13.0	8.0	20.4	PG13.5	50	無 NO
A0KCB000130G16	9.0 ~ 13.0	8.0	22.5	PG16	50	有 HAVE
A0KCB000140G16	11.5 ~ 14.0	8.0	22.5	PG16	50	有 HAVE
A0KCB000190G21	15.5 ~ 19.0	10.0	28.3	PG21	50	有 HAVE
A0KCB000095M16	6.5 ~ 9.5	8.0	16.0	M16X1.5	50	無 NO
A0KCB000095M20	6.5 ~ 9.5	8.0	20.0	M20X1.5	50	有 HAVE
A0KCB000130M16	9.0 ~ 13.0	8.0	16.0	M16X1.5	50	無 NO
A0KCB000130M20	9.0 ~ 13.0	8.0	20.0	M20X1.5	50	有 HAVE
A0KCB000140M20	11.5 ~ 14.0	8.0	20.0	M20X1.5	50	有 HAVE
A0KCB000190M25	15.5 ~ 19.0	8.0	25.0	M25X1.5	50	有 HAVE

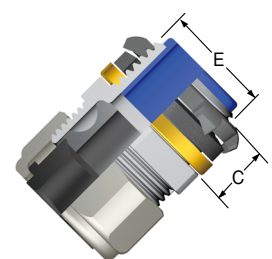

• 防護等級IP68

• Protection degree IP68.

# 金屬電纜接頭

## METAL CABLE GLAND

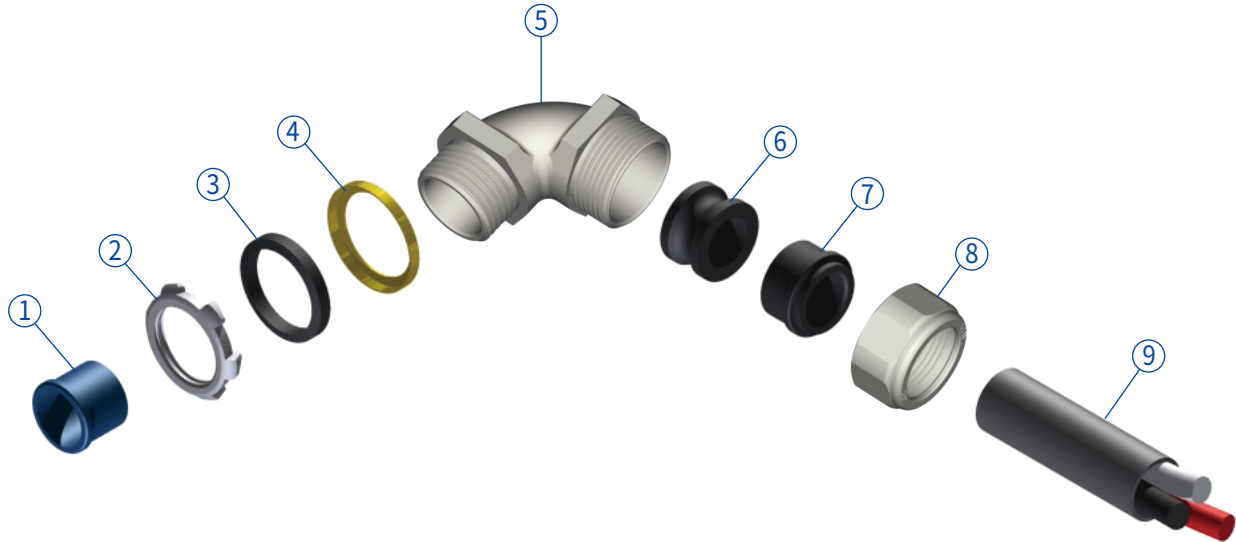

- |        |                    |          |              |
|--------|--------------------|----------|--------------|
| 1.絕緣套  | (Insulating liner) | 2.太陽型螺帽  | (Lock nut)   |
| 3.油環   | (O-Ring)           | 4.金屬油環墊片 | (O-Ring cap) |
| 5.接頭本體 | (Body)             | 6.束線圈    | (Grip seal)  |
| 7.柱形墊  | (Busing)           | 8.後蓋螺帽   | (Cap nut)    |
| 9.電纜線  | (Cable)            |          |              |

### TYPE-KCL(90° Angle)

型號 Catalog No.	適用電纜線徑 Suit for cable size (mm)	尺寸 Dimension(mm)		牙規格 Thread	包裝數量 pcs/bag	金屬螺帽 Metal nut
		C	E			
A0KCL000095F04	6.5 ~ 9.5	13.0	20.9	PF1/2"	50	有 HAVE
A0KCL000130F04	9.0 ~ 13.0	13.0	20.9	PF1/2"	50	有 HAVE
A0KCL000140F04	11.5 ~ 14.0	13.0	20.9	PF1/2"	50	有 HAVE
A0KCL000190F06	15.5 ~ 19.0	16.0	26.4	PF3/4"	50	有 HAVE
A0KCL000095M20	6.5 ~ 9.5	9.0	20.0	M20X1.5	50	有 HAVE
A0KCL000130M20	9.0 ~ 13.0	9.0	20.0	M20X1.5	50	有 HAVE
A0KCL000140M20	11.5 ~ 14.0	9.0	20.0	M20X1.5	50	有 HAVE

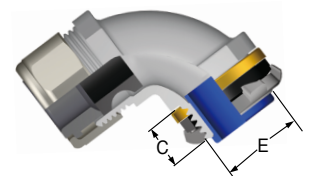

• 防護等級IP68

• Protection degree IP68.

# 塑鋼電纜接頭

## POLYESTER CABLE GLAND

中華民國專利號碼：第M460437號  
R.O.C. Patent No. : M460437



- 1.螺帽 (Nut)
- 2.墊片 (Packing)
- 3.接頭本體 (Body)
- 4.橡膠束管 (Rubber busing)
- 5.夾緊爪 (Claw)
- 6.後蓋螺帽 (Cap nut)
- 7.電纜線 (Cable)

### TYPE-KEB (Straight)

型號 Catalog No.	適用電纜線徑 Suit for cable size (mm)	尺寸 Dimension (mm)			牙規格 Thread	包裝 數量 pcs/bag
		B	C	E		
* A0KEB000100F04	6.0 ~ 10.0	44.5	12.0	20.9	PF1/2"	50
* A0KEB000140F04	9.0 ~ 14.0	44.5	12.0	20.9	PF1/2"	50
* A0KEB000140F06	9.0 ~ 14.0	52.0	15.0	26.4	PF3/4"	50
* A0KEB000180F06	13.0 ~ 18.0	51.0	15.0	26.4	PF3/4"	50
A0KEB000250F10	18.0 ~ 25.0	61.5	16.0	33.2	PF1"	10
A0KEB000300F12	24.0 ~ 30.0	65.0	18.0	41.9	PF1 1/4"	10
* A0KEB000410F14	30.0 ~ 41.0	65.5	18.0	47.8	PF1 1/2"	10
A0KEB000510F20	40.0 ~ 51.0	72.5	22.0	59.6	PF2"	10

A0KEB000070G07	4.0 ~ 7.0	39.5	8.0	12.5	PG7	50
* A0KEB000070G09	4.0 ~ 7.0	43.5	10.0	15.2	PG9	50
* A0KEB000100G09	6.0 ~ 10.0	42.5	10.0	15.2	PG9	50
* A0KEB000070G11	4.0 ~ 7.0	43.5	10.0	18.6	PG11	50
* A0KEB000100G11	6.0 ~ 10.0	42.5	10.0	18.6	PG11	50
* A0KEB000070G13	4.0 ~ 7.0	43.5	10.0	20.4	PG13.5	50
* A0KEB000100G13	6.0 ~ 10.0	42.5	10.0	20.4	PG13.5	50
* A0KEB000100G16	6.0 ~ 10.0	44.0	12.0	22.5	PG16	50
* A0KEB000140G16	9.0 ~ 14.0	43.0	12.0	22.5	PG16	50
* A0KEB000140G21	9.0 ~ 14.0	48.0	12.0	28.3	PG21	50
* A0KEB000180G21	13.0 ~ 18.0	47.0	12.0	28.3	PG21	50
* A0KEB000250G29	18.0 ~ 25.0	55.5	12.0	37.0	PG29	10
A0KEB000300G36	24.0 ~ 30.0	57.0	12.0	47.0	PG36	10
* A0KEB000410G36	30.0 ~ 41.0	59.5	12.0	47.0	PG36	10

* A0KEB000070M16	4.0 ~ 7.0	45.5	12.0	16.0	M16X1.5	50
* A0KEB000100M16	6.0 ~ 10.0	44.5	12.0	16.0	M16X1.5	50
* A0KEB000100M16	6.0 ~ 10.0	44.0	12.0	16.0	M16X1.5	50
* A0KEB000100M20	6.0 ~ 10.0	45.5	13.0	20.0	M20X1.5	50
* A0KEB000140M20	9.0 ~ 14.0	45.0	13.0	20.0	M20X1.5	50
* A0KEB000140M25	9.0 ~ 14.0	50.0	13.0	25.0	M25X1.5	50
* A0KEB000180M25	13.0 ~ 18.0	48.5	13.0	25.0	M25X1.5	50
* A0KEB000250M32	18.0 ~ 25.0	57.5	15.0	32.0	M32X1.5	10
A0KEB000300M40	24.0 ~ 30.0	59.5	15.0	40.0	M40X1.5	10
* A0KEB000410M50	30.0 ~ 41.0	62.5	15.0	50.0	M50X1.5	10

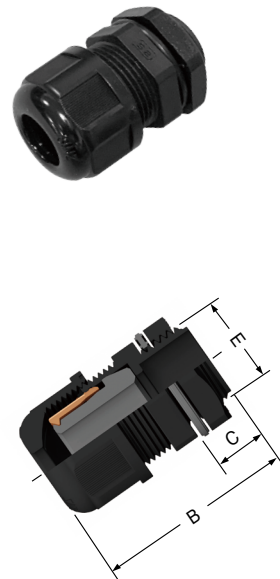

- 防護等級IP68
- (\*) 量產

- Protection degree IP68.
- (\*) Massive Production

# 軍規電纜轉接頭 (塑鋼)

MS-PLUG/CONNECTORS ADAPTER (Polyester)

中華民國專利號碼：第M460437號  
R.O.C. Patent No. : M460437



1. 墊片 (Packing)
2. 接頭本體 (Body)
3. 橡膠束管 (Rubber busing)
4. 夾緊爪 (Claw)
5. 後蓋螺帽 (Cap nut)
6. 電纜線 (Cable)

## TYPE-KES

型號 Catalog No.	適用電纜線徑 Suit for cable size (mm)	MS 電源插座規格		牙規格 Thread	單量 Weight (g/pc)
		Same MS-3057	MS-Plus Size		
A0KES00007010A	4.0 ~ 7.0	10A	18	1"X20UNEF	16.7
A0KES00007012A	4.0 ~ 7.0	12A	20、22	1 3/16"X18UNEF	17.6
A0KES00010010A	6.0 ~ 10.0	10A	18	1"X20UNEF	15.4
A0KES00010012A	6.0 ~ 10.0	12A	20、22	1 3/16"X18UNEF	16.2
A0KES00014010A	9.0 ~ 14.0	10A	18	1"X20UNEF	17.2
A0KES00014012A	9.0 ~ 14.0	12A	20、22	1 3/16"X18UNEF	17.8
A0KES00018016A	13.0 ~ 18.0	16A	24、28	1 7/16"X18UNEF	26.4
A0KES00025016A	18.0 ~ 25.0	16A	24、28	1 7/16"X18UNEF	43.4



• 防護等級IP68

• Protection degree IP68.

## 金屬90°角形貼壁出線座

## METAL 90° ANGLE-SHAPED WALL-MOUNTED OUTLET SOCKET

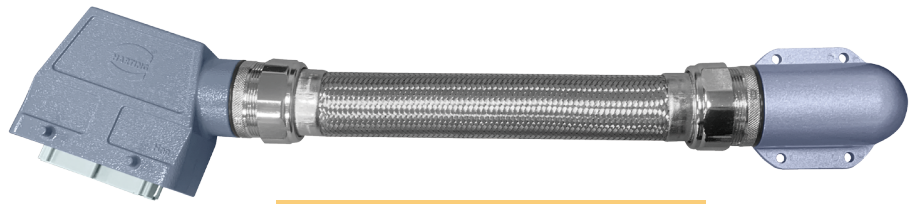

使用例 (Application example)

## TYPE-AK01

## 配件 (Accessories)

1. O型環 (O-ring)
2. 防水套 (Waterproof Case)
3. 管夾 (Pipe clamp)
4. 螺絲和螺帽 (Screws and nuts)

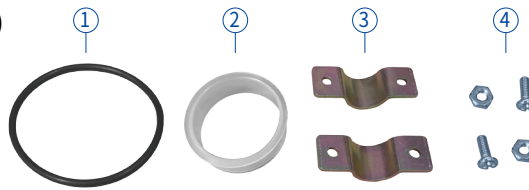

## 產品特性：

- (一) 鍍鎳鋅合金材質，貼壁90°接頭。
- (二) 可節省安裝空間和高度。
- (三) 增強物理性的保護。
- (四) 廣泛用於四軸及五軸綜合加工機。

## Product Features:

- (1) Nickel-plated zinc alloy material, 90° joints attached to the wall.
- (2) Can save installation space and height.
- (3) Enhance physical protection.
- (4) Widely used in four-axis and five-axis comprehensive processing machines.

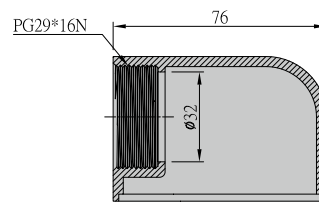
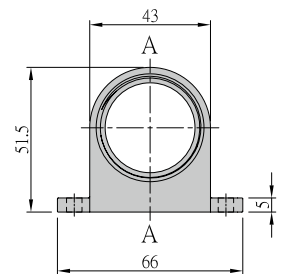

A-A 剖視圖

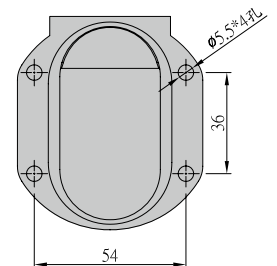

## MTR 金屬轉接頭

## MTR METAL ADAPTER

## TYPE-MTR

型號 Catalog No.	尺寸 Dimension (mm)			PG 內牙 PG inner teeth	PG 外牙 PG externa teeth	重量 Weight (g/pc)
	A	B	C			
A0MTR00G160G21	9.0	13.0	13.0	PG16	PG21	23.4
A0MTR00G210G29	9.0	13.0	13.0	PG21	PG29	41.2
A0MTR00G290G36	8.5	12.0	12.0	PG29	PG36	72.4

型號 Catalog No.	尺寸 Dimension (mm)			PG 內牙 PG inner teeth	PG 外牙 PG externa teeth	重量 Weight (g/pc)
	A	B	C			
A0MTR00G210G16	8.0	22.0	12.0	PG21	PG16	31.0
A0MTR00G290G21	10.0	24.0	12.0	PG29	PG21	47.4
A0MTR00G360G29	8.0	24.5	14.0	PG36	PG29	81.2

